



# HDC Heavy-Duty Tool Cabinets



HDC-H55 Handle (with EVA pad)  
545W x 665D x 30H mm

HDC-5PG  
 1000  PP 5"caster  
360° rotational casters with brake

## Features



Heavy-duty



Telescopic slides



Alignment pin



Optional casters



Chip-proof



Drawer dividers



Loading tested



Patented

- Multiple cabinet heights available: 700 mm / 1000 mm / 1200 mm
- Add legs or adjust the height of the cabinet using the 4 wheel mounts, which also protect the base of the cabinet
- Smooth, rounded edges ensure user safety

How to read SHUTER HDC model numbers:

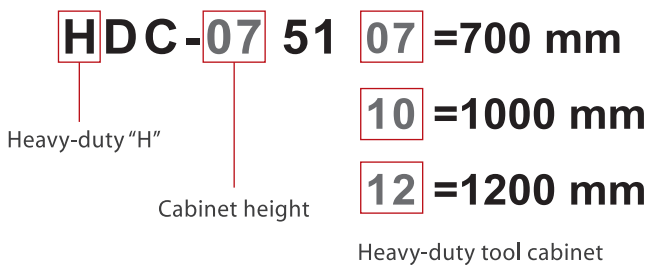

H=120cm



HDC-1291

H=100cm



HDC-1062

H=70cm

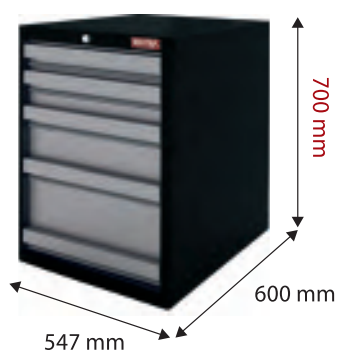

HDC-0751

## Drawers

- Multiple drawer heights available: 75 mm / 100 mm / 150 mm / 200 mm
- Drawers made of 1.2 mm cold rolled steel, which has been phosphate-treated and powder-coated for better resistance
- Heavy-duty telescopic slides with double extensions can hold up to 350 kg per pair
- Standard heavy-duty telescopic slides can hold up to 100 kg per pair

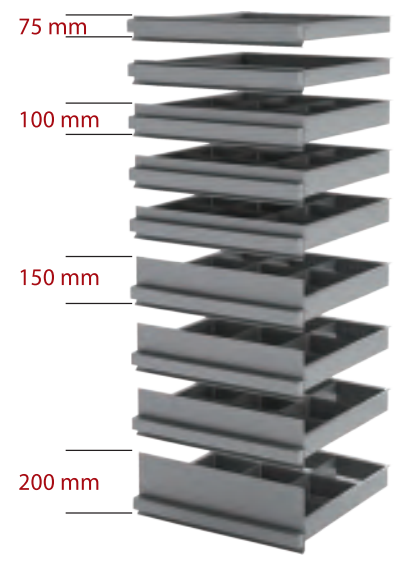

### Drawer divider

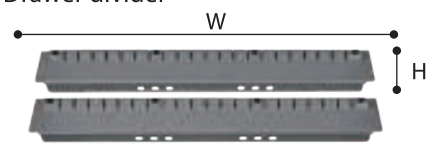

### Drawer divider sizes (mm)

Height	Product Code	Dimensions
75	IA-3	45x435
100	IA-4	70x435
150/200	IA-6	120x435

### Drawer spacer

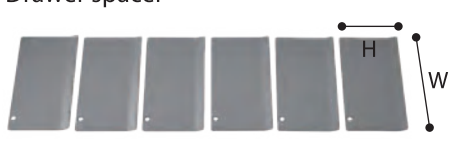

### Drawer spacer sizes (mm)

Height	Product Code	Dimensions
75	IB-3S	43x140
	IB-3L *	43x214
100	IB-4S	68x140
	IB-4L *	68x214
150/200	IB-6S *	118x140
	IB-6L	118x214

\* Optional accessories



Drawer type 1 (75 mm or 100 mm H)  
Includes 2 dividers and 6 spacers

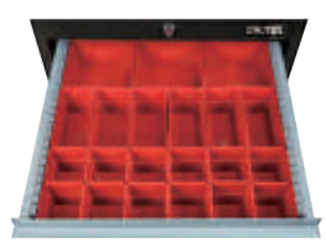

Drawer type 2 has complimentary SB drawer insert  
\* SB drawer insert cannot be used in 75 mm drawer



Drawer type 3 (150 mm or 200 mm H)  
Includes 1 divider and 2 spacers

### HDC drawer dimensions (mm)

A	B	C
75	58	50
100	83	75
150	133	125
200	183	125

A – Drawer Front B – Drawer Interior C – Complete Drawer

### Cross-sectional view of drawer

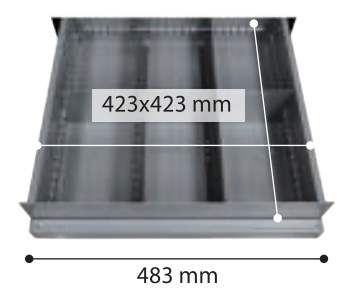



1. Smooth, rounded edges ensure user safety
2. Interconnected lock design means all drawers can be locked or unlocked together
3. Safety clip on drawers ensures locked drawers will not open when other drawers are in use
4. Heavy-duty telescopic slides with double extensions are made of 3 mm steel sheet and can hold up to 200 kg per pair



## 120 cm Heavy-Duty Tool Cabinets (HDC)



HDC-1261 } 6 drawers  
547W x 600D x 1200H mm

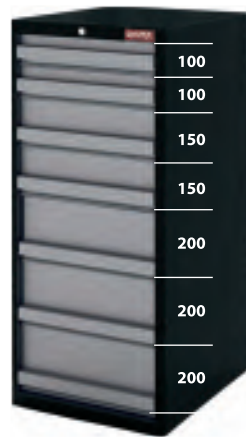

HDC-1271 } 7 drawers  
547W x 600D x 1200H mm



HDC-1272 } 7 drawers  
547W x 600D x 1200H mm



HDC-1281 } 8 drawers  
547W x 600D x 1200H mm

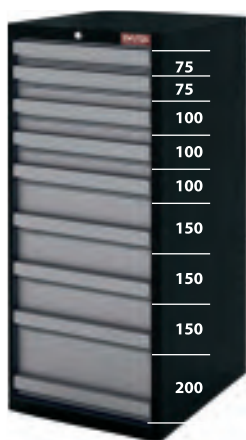

HDC-1291 } 9 drawers  
547W x 600D x 1200H mm

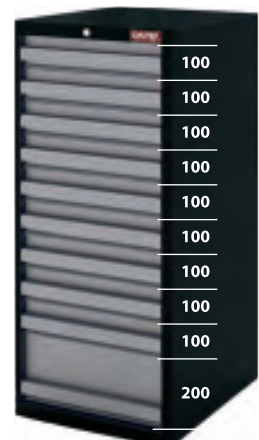

HDC-1210 } 10 drawers  
547W x 600D x 1200H mm



## 100 cm Heavy-Duty Tool Cabinets (HDC)

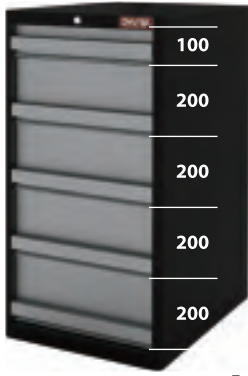

HDC-1051   
547W x 600D x 1000H mm

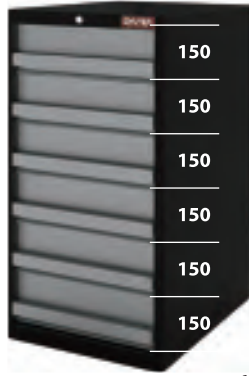

HDC-1061   
547W x 600D x 1000H mm

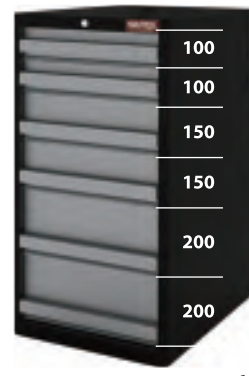

HDC-1062   
547W x 600D x 1000H mm

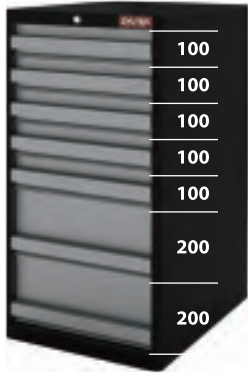

HDC-1071   
547W x 600D x 1000H mm

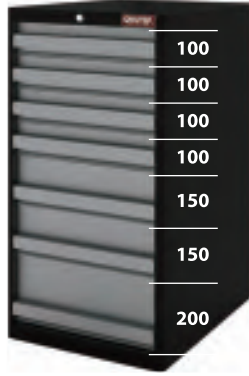

HDC-1072   
547W x 600D x 1000H mm

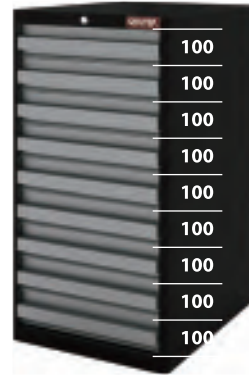

HDC-1091   
547W x 600D x 1000H mm

## 70 cm Heavy-Duty Tool Cabinets (HDC)



HDC-0741   
547W x 600D x 700H mm



HDC-0742   
547W x 600D x 700H mm

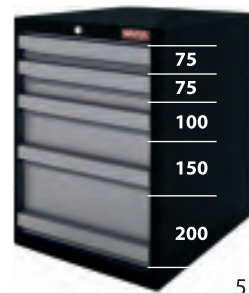

HDC-0751   
547W x 600D x 700H mm



HDC-0752   
547W x 600D x 700H mm



HDC-0761   
547W x 600D x 700H mm



HDC-0771   
547W x 600D x 700H mm